

DAVE M.

PARTS LIST

PACSETER *



ELECTRIC
&
GAS
CONVECTION
OVENS

Pacsetter

Parts Still Available

GARLAND produces both Electric and Gas Convection Ovens.

Electric units are identified by the prefix letter "E" and gas units by the prefix letter "G". Many parts are interchangeable. This will be noted under the proper prefix heading.

The second letter of the model number if "C" indicates Custom design, if "I" denotes Industry Standard design. The Custom design unit includes certain standard features (i.e. lighted control panel, load control, etc.) which are not available on the Industry Standard unit. Refer to the proper heading for parts unique to either unit.

The third (and fourth if applicable) figure(s) if "I" indicates a single oven or if "II" two stacked oven sections.

The last two figures denote the depth of the unit with 36 describing the shallow unit and 42 indicating the deep unit. This information is necessary when purchasing such replacement parts as racks or rack holders. Specific information is provided in the descriptive narrative.

*CHH
1/2 in. from
1244703
188-06*

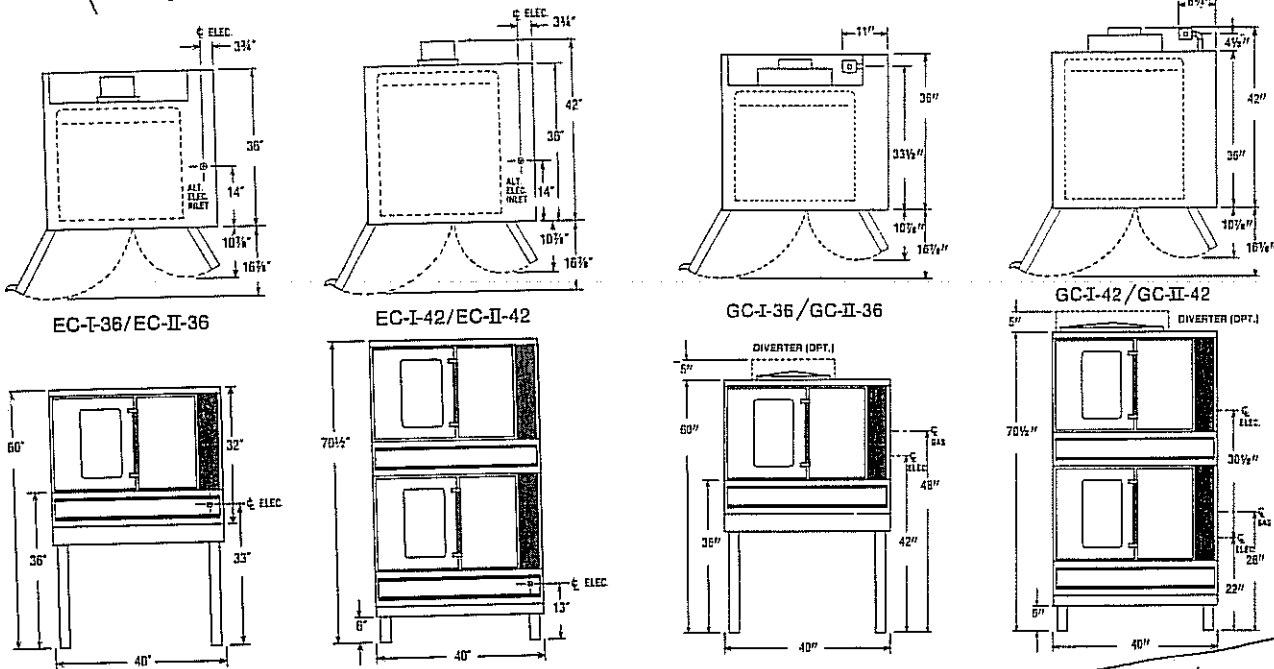

*X 1183199 Leg support for any
open base 36"
1040098 55
99 66
42"
1040097 66*

ELECTRIC & GAS CONVECTION OVENS – LEG SECTION

REF	PART NUMBER	DESCRIPTION	AMOUNT EACH TOTAL UNIT			
			PREFIX EC	PREFIX GC	PREFIX EI	PREFIX GI
		SECTION A: BASE & LEGS				
	1011599	Base Frame Assy	36"/42"	36"/42"	36"/42"	36"/42"
	1016699	2" Base Frame Assy (GC) (used on double stacked oven units)	1	1	1	1
	1013029	4" Base Frame Assy (GC) (used with single oven units, any type)	1	1	1	1
	1019101	Leg Locking Coupler (GC)	4	4	4	4
	1019102	Leg Locking Coupler (Chrome)	4	4	4	4
	1013102	Legs (GC) 2 x 26 5/8 (Single oven units)	4	4	4	4
	1013102	Legs (Chrome) 2 x 26 5/8 (Single oven units)	4	4	4	4
	1027799	LEG ASSY (Double oven units) 1013111 66 12 CHCUM	4	4	4	4
	1027600	LEG RETAINER (Double oven units)	4	4	4	4
	1027800	Heavy Duty Caster (Optional double oven units)	2	2	2	2
	1027801	Heavy Duty Caster w/brake (Optional double oven units)	2	2	2	2

ELECTRIC & GAS CONVECTION OVENS – OVEN SECTION

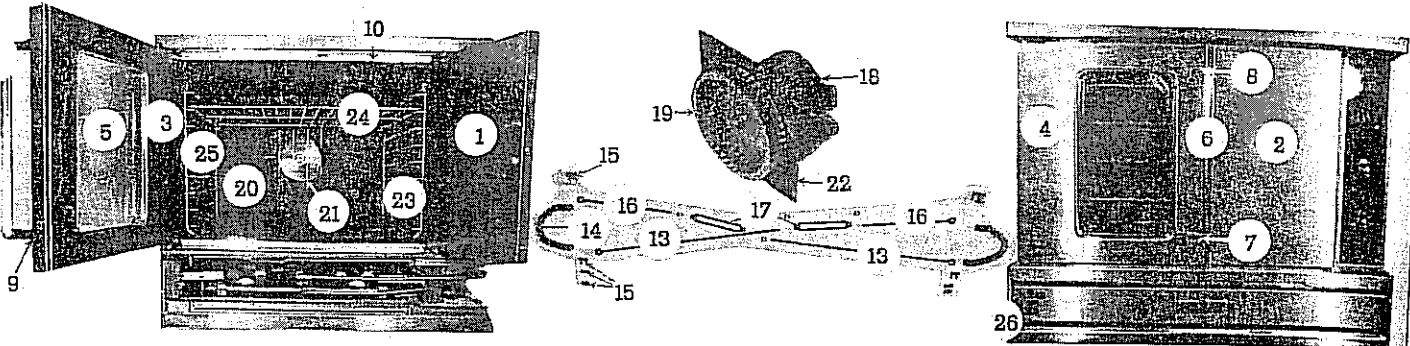

REF	PART NUMBER	DESCRIPTION	AMOUNT EACH SECTION			
			PREFIX EC	PREFIX GC	PREFIX EI	PREFIX GI
		SECTION B: OVEN	36"/42"	36"/42"	36"/42"	36"/42"
		<i>1029296 special RT door w/window 250.40</i>				
1	1029298	RIGHT DOOR ASSY	1	1	1	1
2	1011502	Right Door Liner (S/S)	1	1	1	1
	1011402	Right Door Panel (S/S)	1	1	1	1
3	1029299	LEFT DOOR ASSY COMPLETE (Window)(S/S)	1	1	1	1
	1029297	Left Door Solid Assy Complete (S/S)(Optional)	1	1	1	1
	1011799	Left Door Liner Assy (Window)(S/S)	1	1	1	1
	1011798	Left Door Liner Assy (Solid)(S/S)(Optional)	1	1	1	1
4	1011605	Left Door Panel (Window)(S/S)	1	1	1	1
	1011606	Left Door Panel (Solid)(S/S)(Optional)	1	1	1	1
5	1010998	WINDOW ASSY	1	1	1	1
	1011899	Door Frame Assy	1	1	1	1
	1011707	Handle Spacer Tubing	2	2	2	2
	1016799	Oven Door Handle Assy	1	1	1	1
6	1016700	OVEN DOOR HANDLE	1	1	1	1
7	1016701	RIGHT HANDLE END	1	1	1	1
8	1016702	LEFT HANDLE END	1	1	1	1
9	1016703	INSULATOR DOOR HANDLE (Spacer)	2	2	2	2
	1120002	1/4 - 20 ALLEN HEAD SCREW (3" LG)	2	2	2	2
10	1019999	TOP OR BOTTOM DOOR SEAL ASSY	1	1	1	1
	1019998	DOOR SIDE SEAL ASSY	1	1	1	1
	1019600	DOOR SAFETY SWITCH	1	1	1	1
	1021901	Door Catch <i>SPRING STEEL (02 SS CATCH)</i>	1	1	1	1
	1011201	Steel Tubing Spacer	1	1	1	1
	1011203	Bronze Bushing	1	1	1	1
	1010599	Hinge Bracket Assy	1	1	1	1
13	1014200	RIGHT THREAD DOOR ROD (Long)	2	2	2	2
14	1021100	ROLLER CHAIN	2	2	2	2
15	1021100	CONNECTING LINK ASSY <i>1021199 = 201+200 in part</i>	4	4	4	4
16	1014201	LEFT THREAD DOOR ROD (Short)	2	2	2	2
17	1015000	TURNBUCKLE	2	2	2	2
	1003098	Motor Assy (GCE)	-	-	1	1
	1003099	Motor Assy (CC)	-	-	1	1
18	1003000	MOTOR 115/230V 1725RPM 3/4HZ	1	1	1	1
19	1025301	BLOWER WHEEL	1	1	1	1
20	1010299	Air Baffle Assy (CC)	1	1	-	-
	1010297	Air Baffle Assy (GCE)	-	-	1	1
	1010298	Air Baffle Assy (S/S)	-	-	1	1
	1014400	AIR BAFFLE SPACER	4	4	4	4
21	1014500	Blower Inlet Cover	1	1	1	1
	1013901	THUMB SCREW	4	4	4	4
	1029498	Motor Cable Assy	1	1	1	1
	1029501	Power Supply Cord 115V 6'	-	-	1	1
	1011905	Motor Mount Plate (GCE)	-	-	1	1
22	1011906	Motor Mount Plate (CC)	1	1	-	-
	1029499	Light Cable Assy	1	1	1	1
	1026050	OVEN LIGHT (50 Watt)	2	2	2	2
	1025900	Light Socket Gasket	2	2	2	2
	1025800	Light Socket	2	2	2	2
23	1016800	Clip Rack Guide (S/S)	6	6	6	6
	1012501	Right Side Rack Guide 9 position (suffix 36 only)	1	1	1	1
	1012600	OVEN RACK (suffix 36 only)	5	5	5	5
	1012500	Left Rack Guide 9 position (suffix 36 only)	1	1	1	1
	1012507	Right Side Rack Guide 11 position (suffix 42 only)	1	1	1	1
	1012700	OVEN RACK (suffix 42 only)	5	5	5	5
	1012506	Left Side Rack Guide 11 position (suffix 42 only)	1	1	1	1
	1015798	Capillary Tube Guard Assy (GCE)	-	-	1	1
	1015799	Capillary Tube Guard Assy (CC)	1	1	-	-

*HD racks
std 10/12/601
Drops 10/2701*

Treadsetter R side 1013920 6-6 1013921 5-0

REF.	PART NO.	DESCRIPTION	AMOUNT EACH SECTION			
			PREFIX EC	PREFIX GC	PREFIX EI	PREFIX GI
		SECTION B: OVEN (CONTINUED)				
			36"/42"	36"/42"	36"/42"	36"/42"
	1013998	Right Body Side Assy. (GC) with S/S Trim	1	1	1	1
	1013996	Right Body Side Assy. (S/S) with S/S Trim	1	1	1	1
	1013999	Left Body Side Assy. (GC) with S/S Trim	1	1	1	1
	1013997	Left Body Side Assy. (S/S) with S/S Trim	1	1	1	1
	1011309	Main Top (S/S) (Suffix 36 only)	1	1	1	1
	1011395	Main Top Assy. (GC) (Suffix 36 only)	1	1	1	1
	1011311	Main Top (S/S) (Suffix 42 only)	1	1	1	1
	1011394	Main Top (GC) (Suffix 42 only)	1	1	1	1
26	1013395	Combustion Chamber Front Panel Assy. (S/S)	1	1	1	1
	1012399	Combustion Chamber Door Assy. (S/S)	1	1	1	1
	1020101	MAGNETIC CATCH	1	1	1	1
	1008997	Draft Diverter Assy. (Granite Gray)		1		1
	1008996	Draft Diverter Assy. (S/S)		1		1
	1190299	Flue Hood Assy. (Double Oven)				
	1190101	Draft Diverter (8")				
	1190298	Flue Cap Assy. (Single Oven)				
	1190100	Draft Diverter (6")				
		Self front screen				
		1013400 freight steel 1013401 " " deep				

ELECTRIC & GAS CONVECTION OVENS – CONTROLS SECTION

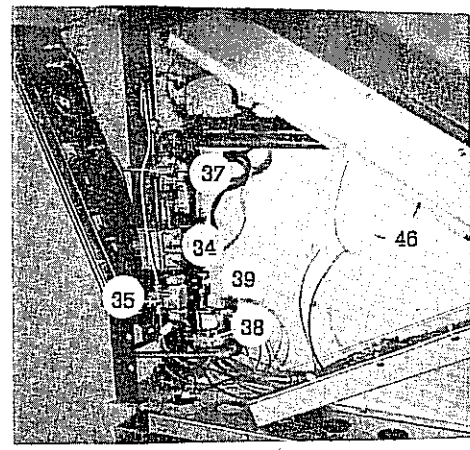
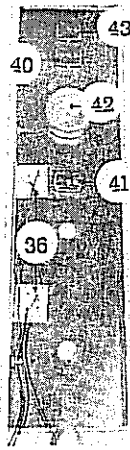
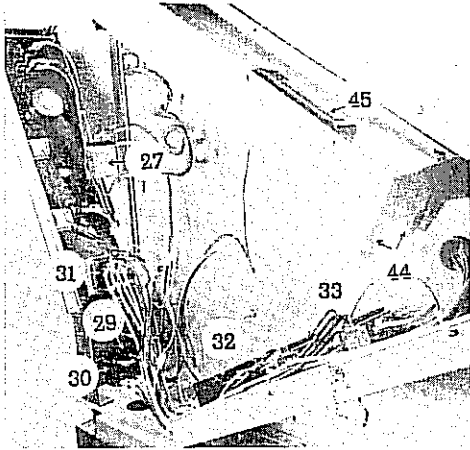
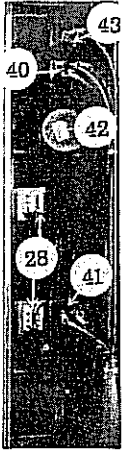

REF.	PART NO.	DESCRIPTION	AMOUNT EACH SECTION			
			PREFIX EC	PREFIX GC	PREFIX EI	PREFIX GI
SECTION C: CONTROLS			36"/42"	36"/42"	36"/42"	36"/42"
27	1032498	"S" CONTROL ASSY. <i>99 mini DE 1/26/82 at 400 only</i>	1		1	
	1032404	DIAL ONLY (for above)	1		1	
28	1017402	PILOT LIGHT 250V Green	2			
	1006499	PILOT LIGHT ASSY. 250V Red			1	
	1006497	PILOT LIGHT ASSY. 115V Red				1
29	1026301	Branch Circuit Breaker-Light (5AMP) 208V/236V/460V	1		1	
30	1026300	Branch Circuit Breaker-Motor 208V/236V/460V <i>15amp Trip/d. 15 Hold.</i>	1		1	
	1022301	Main Breaker Bracket	1		1	
31	1026200	MAIN CIRCUIT BREAKER 208V/236V	1		1	
	1026201	CIRCUIT BREAKER 460V	1		1	
32	1030802	TRANSFORMER 208V	1		1	
	1030801	TRANSFORMER 236V	1		1	
	1033700	TRANSFORMER 460V	1		1	
33	1026100	CONTACTORS 208V/236V/460V <i>460V Tubs 1026101 460V 1026107 2 pole</i>	2		1	
	1029798	Terminal Block Assy. (3 lug)	1		1	
	1029799	Terminal Block Assy. (4 lug) (Opt)	1		1	
	1033500	Terminal Block Cover	1		1	
34	1017599	FDO THERMOSTAT ASSY. 500		1		1
	1017501	DIAL ONLY (for above)		1		1
	1006497	PILOT LIGHT ASSY. 115V Red			1	1
36	1017401	PILOT LIGHT 115V Green		2		
	1028205	Compression Nut		1		1
	1024800	Pilot Spacer (1/2 Tubing X 7/16)		2		2
	1028330	Pilot Tubing (3/16 Tubing X 30" Lg)		1		1
	1028330	Pilot Adj. Filter Assy. <i>1150092</i>		1		1
37	1017200	GAS VALVE		1		1
	1017300	GAS VALVE DIAL		1		1
	1026902	3/8 Female Union		1		1
	1004622	3/8 Nipple 2" LG		1		1
	1004620	3/8 Close Nipple 1" LG		1		1
35	1027000	TS11 SAFETY VALVE		1		1
	1028320	3/16 Tubing 20" LG		1		1
	1028601	3/16 Ferrule		1		1
	1027002	Compression Nut		2		2
	1027102	3/8 Pipe Tee		1		1
38	1027300	GAS SOLENOID		1		1
	1027499	Male Elbow Assy. (3/8 NPT to 7/16 CC)		1		1
	1027401	7/16 Ferrule		1		1
	1027402	7/16 Compression Nut		1		1
	1004623	3/8 Nipple 2 1/2" LG		1		1
	1026702	3/8 - 90° Elbow		1		1
	1004621	3/8 Nipple 1 1/2" LG		1		1
	1026920	3/8 - 90° Female Union		1		1
	1004628	3/8 Pipe 4 3/4" LG		1		1
39	1019500	PRESSURE SWITCH		1		1
	1019503	1/4 Ferrule		1		1
	1019504	Compression Nut		1		1
	1028737	1/4" Tubing (1/4 OD X 37" LG)		1		1
	1029499	Light Cable Assy.	1	1	1	1
	1030042	Wire Nuts	2	2	2	2
	1018407	3/16 Steel Tubing 1 5/16 LG		2		2
	1028800	1" Bushing	1	1	1	1
	1028803	1 3/4" Bushing	1	1	1	1

REF.	PART NO.	DESCRIPTION	AMOUNT EACH SECTION			
			PREFIX EC	PREFIX GC	PREFIX EI	PREFIX GI
SECTION C: CONTROLS (CONTINUED)			36"/42"	36"/42"	36"/42"	36"/42"
40	1032003	10 - 24 WING NUTS		2		2
	1025207	TIMER KNOB	1	1	1	1
	1019204	FAN SWITCH (On-Off-On)	1	1	1	1
41	1019203	LOAD CONTROL SWITCH (On-Off)	1	1	1	1
42	1025209	60-Minute Timer Assy. 204 Timer 600V	1	1	1	1
43	1019205	MOMENTARY SWITCH	1	1	1	1
	1020498	Florescent Light Brk. W.A.	1	1		
44	1022900	FLORESCENT LIGHT SOCKETS	4	4		
45	1022800	FLORESCENT LIGHT BALLAST	1	1		
46	1023000	FLORESCENT LIGHT	2	2		
	1022011	Wire Diagram 115V		1		
	1022002	Wire Diagram 208V/236V	1			
	1022012	Wire Diagram 115V				1
	1022001	Wire Diagram 208V			1	
	1022007	Wire Diagram 460V			1	
	1125210	GARLAND 10 GA. STRANDED ASBESTOS FIXTURE WIRE (Red)				
	1125212	GARLAND 12 GA. STRANDED ASBESTOS FIXTURE WIRE (Red)				
	1125014	GARLAND 14 GA. STRANDED ASBESTOS FIXTURE WIRE (Black) (Part Number refers only to wire specifications excluding length. Prices available on application.)				
	1009099	Instruction Manual (Gas)		1		1
	1009098	Instruction Manual (Electric)	1		1	
	1022599	Control Panel Assy. Comp.	1			
	1022598	Control Panel Assy. Comp.			1	
	1011199	Control Panel Assy. Comp.		1		
	1011198	Control Panel Assy. Comp.				1
	1022596	Control Panel Assy. Comp. (460V)	1			
	1022594	Control Panel Assy. Comp. (460V)			1	
	1130100	Fuse Holder	3		2	
	1130101	Fuse 20 AMP	3		2	
<p><i>out Feb 81</i></p> <p><i>KTK R20</i></p> <p><i>1019600 Door softly mounted</i></p> <p><i>33.34</i></p> <p><i>20 feet pipe</i></p> <p><i>1130102 holder</i></p> <p><i>1130103 fuse (SC20)</i></p> <p><i>SS panel screened 1011165 gas</i></p> <p><i>18.71 1981</i></p> <p><i>1089004 L. Rogeloh</i></p> <p><i>Screened SS Gas 1011105</i></p> <p><i>" " elect - 1022503</i></p> <p><i>" " plastic gas 1011104</i></p> <p><i>" " elec 1022501</i></p> <p><i>Control panel for</i></p> <p><i>1257501</i></p> <p><i>1257500</i></p> <p><i>115V</i></p> <p><i>208/236V</i></p>						

ELECTRIC & GAS CONVECTION OVENS – ELEMENT & BURNER SECTION

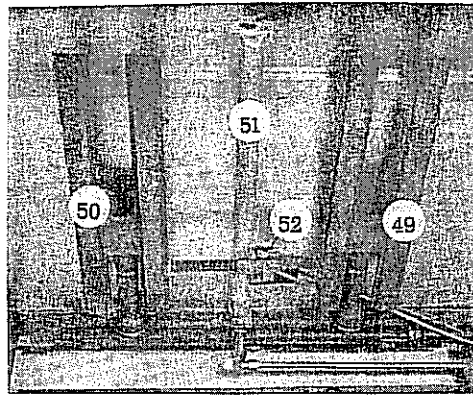
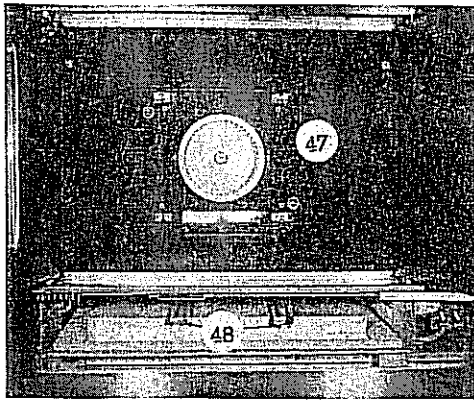

REF	PART NUMBER	DESCRIPTION	AMOUNT EACH SECTION			
			PREFIX EC 36"/42"	PREFIX GC 36"/42"	PREFIX EI 36"/42"	PREFIX GI 36"/42"
SECTION D: ELEMENTS & BURNERS						
47	1032199	HEATER ELEMENT ASSY 208V	1	-	1	-
47	1032198	HEATER ELEMENT ASSY 236V	1	-	1	-
47	1032196	Heater Element Assy 460V 47	1	-	1	-
	1011099	HEATER ELEMENT - Front 208V	1	-	1	-
	1011096	HEATER ELEMENT - Front 236V	1	-	1	-
	1011095	Heater Element - Front 460V 93	1	-	1	-
	1011098	HEATER ELEMENT - Center 208V	1	-	1	-
	1011095	HEATER ELEMENT - Center 236V	1	-	1	-
	1011092	Heater Element - Center 460V 49	1	-	1	-
	1011097	HEATER ELEMENT - Rear 208V	1	-	1	-
	1011094	HEATER ELEMENT - Rear 236V	1	-	1	-
	1011091	Heater Element - Rear 460V 49	1	-	1	-
	1017100	Top Element Retainer - All Voltages	4	-	4	-
	1017101	Bottom Element Retainer - All Voltages	4	-	4	-
48	1032300 52	LOAD CONTROL ELEMENT 212V 1375W	2	-	-	-
	1032301 03	LOAD CONTROL ELEMENT 236V/460V 1500W	2	-	-	-
	1032903	Element Retaining Clips	2	-	-	-
	1032901	Front Element Rest	1	-	-	-
	1032902	Element Retainer Shield	2	-	-	-
	1015899	Combustion Chamber Front Shield Assy	-	1	-	1
49	1014997	RIGHT BURNER ASSY	-	1	-	1
50	1014998	LEFT BURNER ASSY	-	1	-	1
51	1028198	STEEL BURNER ASSY	-	1	-	1
	1017600	ORIFICE FITTING	-	2	-	2
	1020831	ORIFICE - NAT 1037731	-	2	-	2
	1020840	ORIFICE - LP 1037749	-	2	-	2
	1004845	Reducing Coupling (1/2 x 3/8 NPT)	-	1	-	1
	1004631	3/8 Nipple 6 1/2" Lg	-	1	-	1
	1026730	1/8 Street Elbow	-	1	-	1
	1027900	Straight Connector (1/8 NPT to 1/4 CC)	-	1	-	1
	1019503	1/4 Ferrule	-	1	-	1
	1019504	Compression Nut	-	1	-	1
	1028299	PILOT ASSY COMPLETE - NAT	-	1	-	1
	1028200	Pilot 2CH-10	-	1	-	1
	1028202	Orifice No. 18 Bell	-	1	-	1
	1028204	Reducing Ferrule for 3/16 Tubing	-	1	-	1
52	1019400	THERMOCOUPLE 30" Lg M22 30 4/91 1019436	-	1	-	1
	1028298	PILOT ASSY COMPLETE - LP	-	1	-	1
	1028203	Orifice No. 10 Bell	-	1	-	1
	1088200	Orifice Fitting	-	1	-	1
	1024004	Steel Burner Tubing 29 1/2" Lg	-	1	-	-
	1024005	Steel Burner Tubing	-	-	-	1
	1021337	ORIFICE - NAT	-	1	-	1
	1021352	ORIFICE - LP	-	1	-	1
	1026702	Pipe Elbow (3/8 to 3/8)	-	1	-	1
	1027400	Male Elbow	-	1	-	1
	1028400	Ground Lug	-	1	-	1
	1014807	Junction Box (GG) (suffix 36 only)	1	-	1	-
	1014808	Junction Box (GG) (suffix 42 only)	1	-	1	-